

BÖLÜM

08

TRAKTÖR

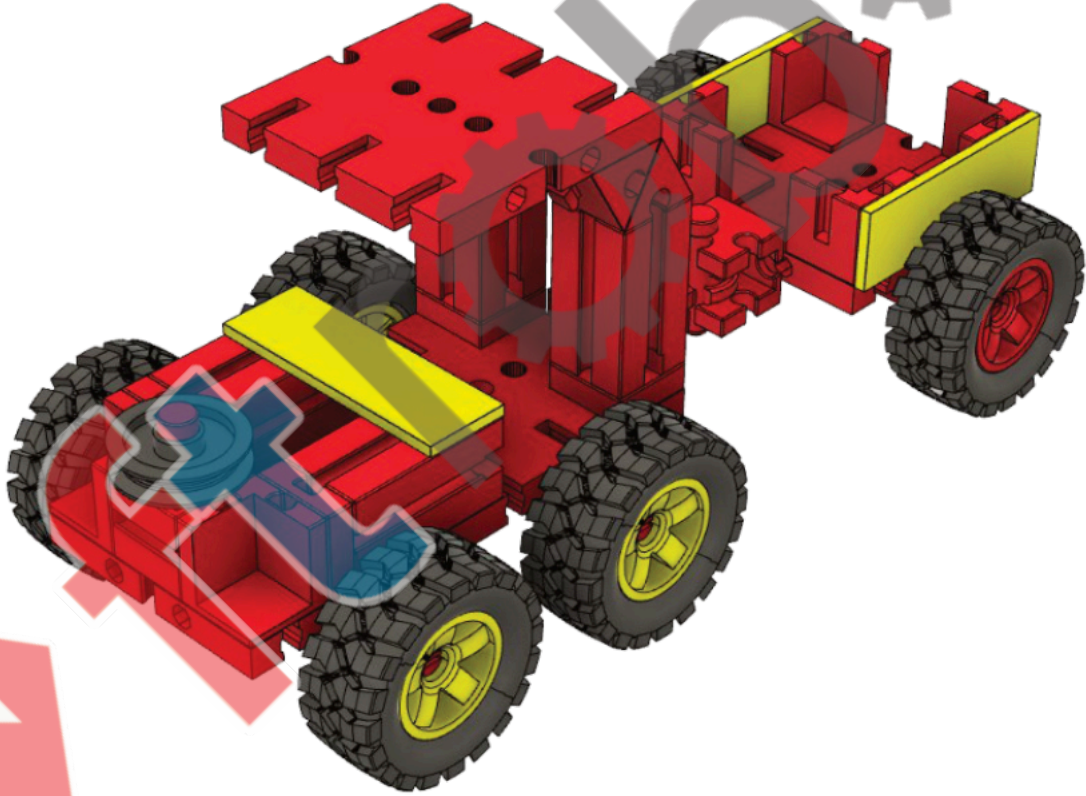

Merhaba çocuklar, bu bölümde sizinle römorklu mini bir traktör yapacağız. Ve tabii ki traktörlerin ne olduğunu, nerelerde kullanıldığını da öğreneceğiz.

3 Etkinlik / 1 Tasarım

Konuyu Keşfedelim

Ekmek, poğaç, kurabiye, börek... Dur saymaya devam etme karnımız acıktı diyenler olabilir. Bu leziz yemekleri neden saydığımı söyleyeyim. Bunların hepsinin yapımında un kullanılır. Peki benim unla alakamın ne olduğunu iyice merak etmişsinizdir. Kendimi tanıtayım. Ben bir traktörüm.



Tarlalarda çalışırım. Tarla sürülürken, buğday ekilirken, biçilirken, olgunlaşan altın gibi buğday başakları un fabrikasına taşınırken ben hep çalışırım. Evet doğru bildiniz. Bu leziz yiyecekler için gereken unun üretiminde ben çok çalışırım.

Tabii siz afiyetle

yiyinge de ne yorgunluğum kalır ne bir şey. O kadar mutlu olurum ki anlatamam. Sevinçten kocaman tekerleklerimle tarlada turlar atar dururum.



Zaten benden başkası da bu işin üstesinden gelemez bilirim. Bir biçerdöver kardeş var bana yardım eden, onun haricinde kim tarlada çalışacak kadar güçlü ki?



**GÖREV**

Arkasında römorku da olan minik bir traktör yapalım.



49
Blok



20dk



MODEL
TRAKTÖR

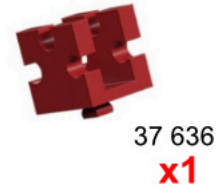
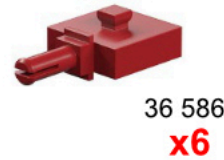
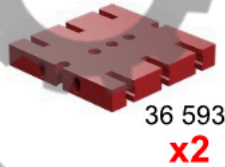
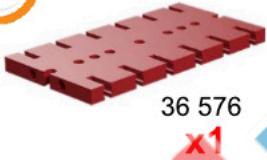
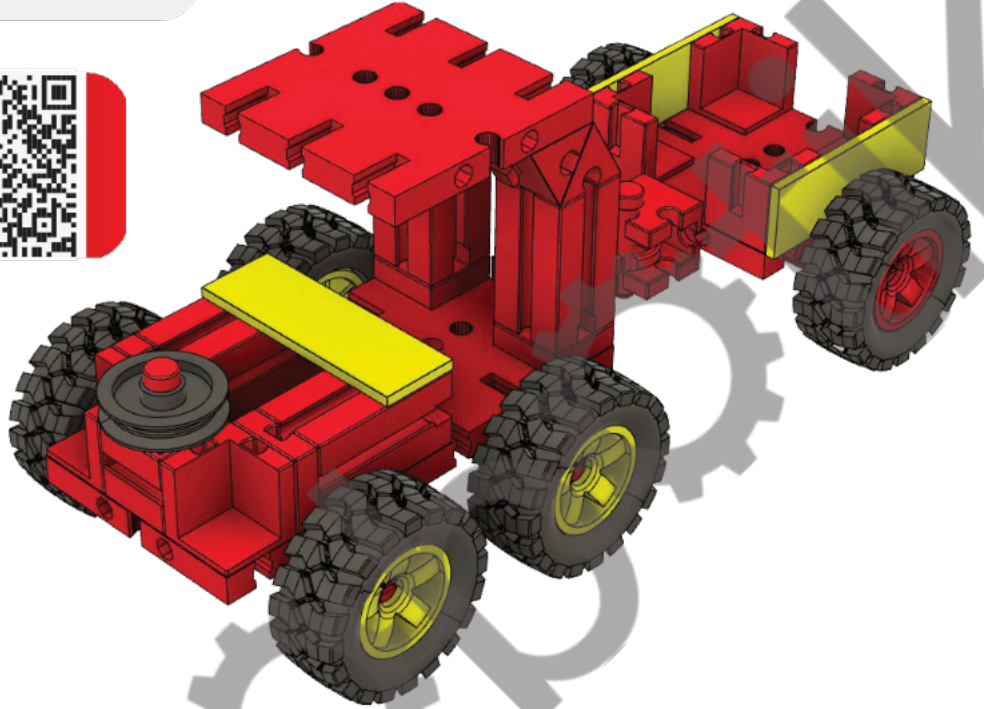

1

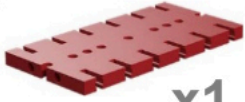

x1



x4



x1



x1

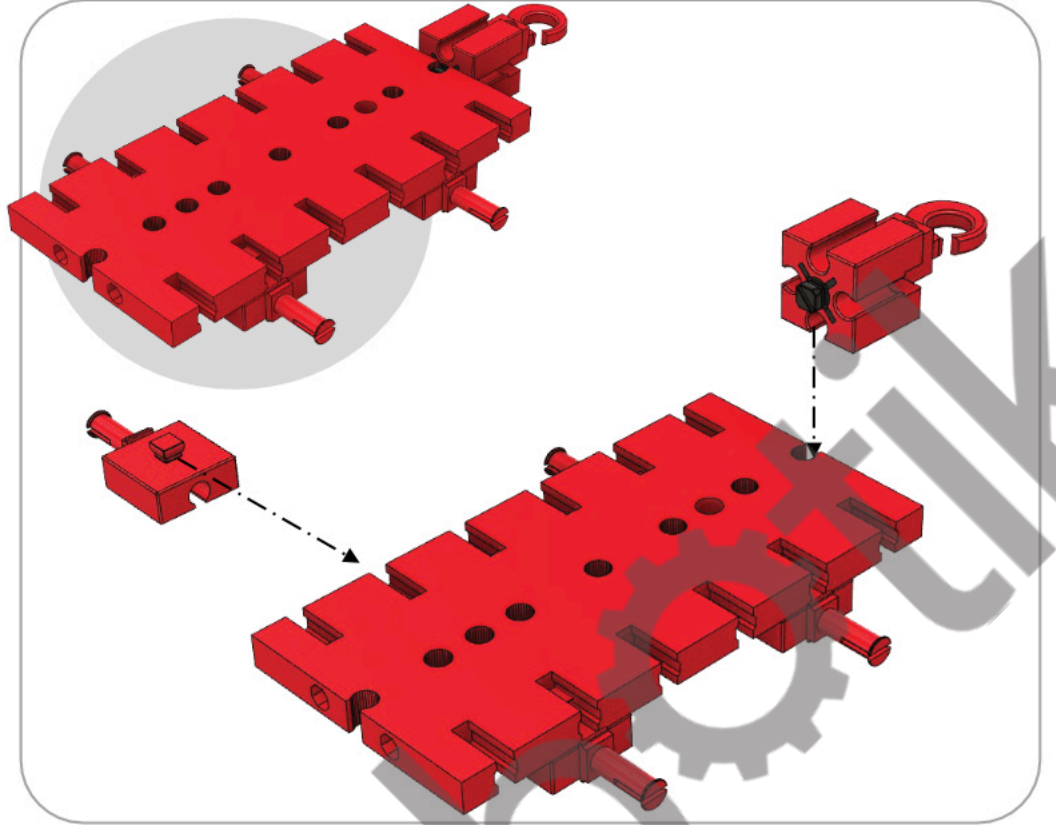

2



x2



x2





x2

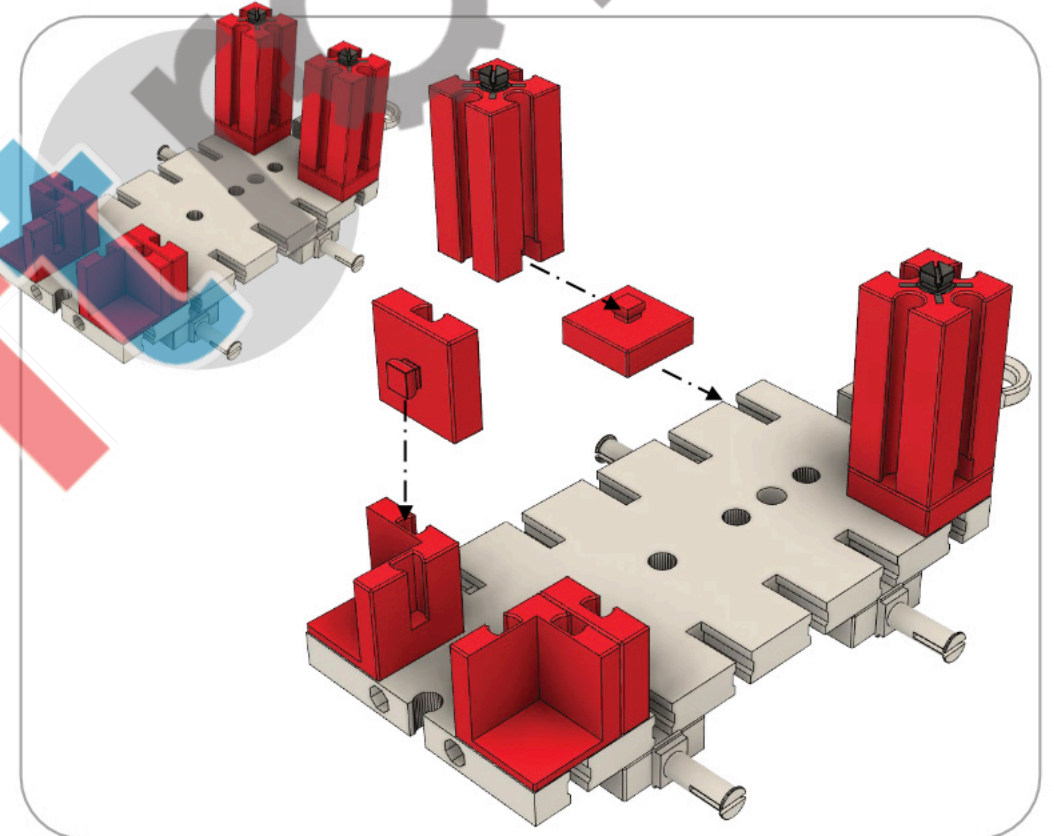

x2





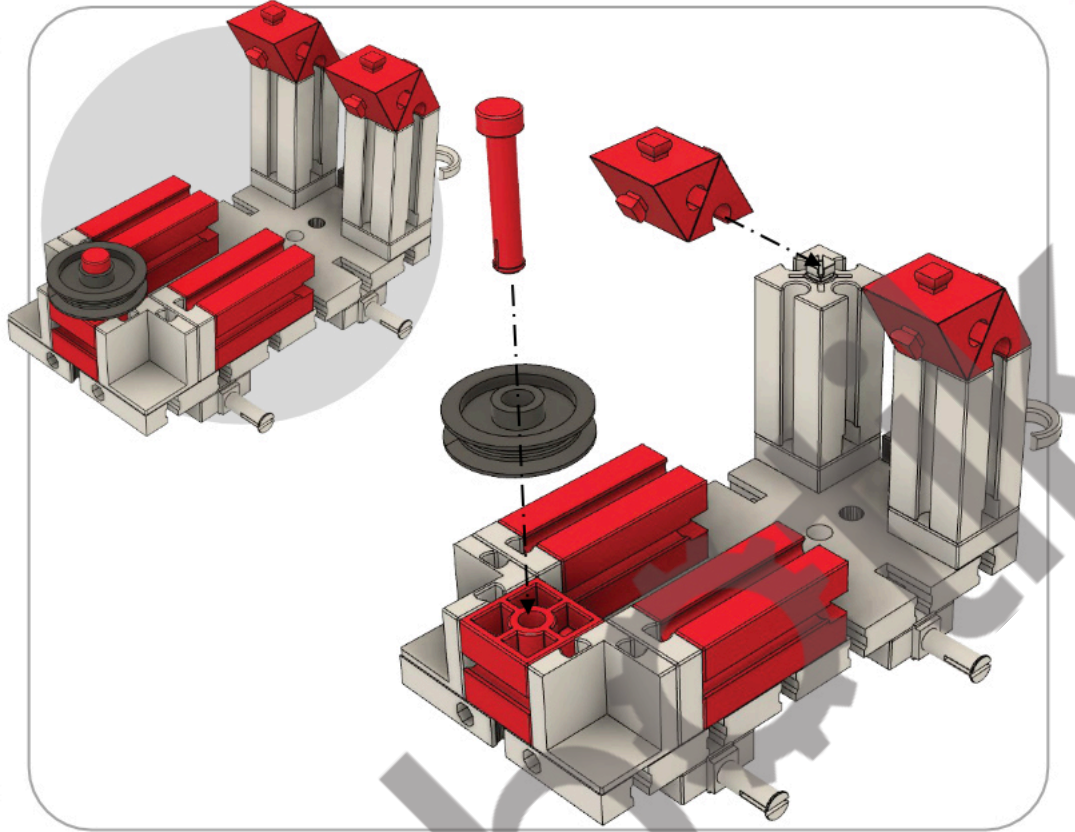

3

-  x2
-  x1
- 60  x4
-  x1
-  x1

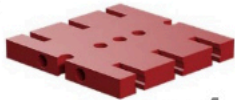

4

-  x1
-  x2
-  x2
-  x1

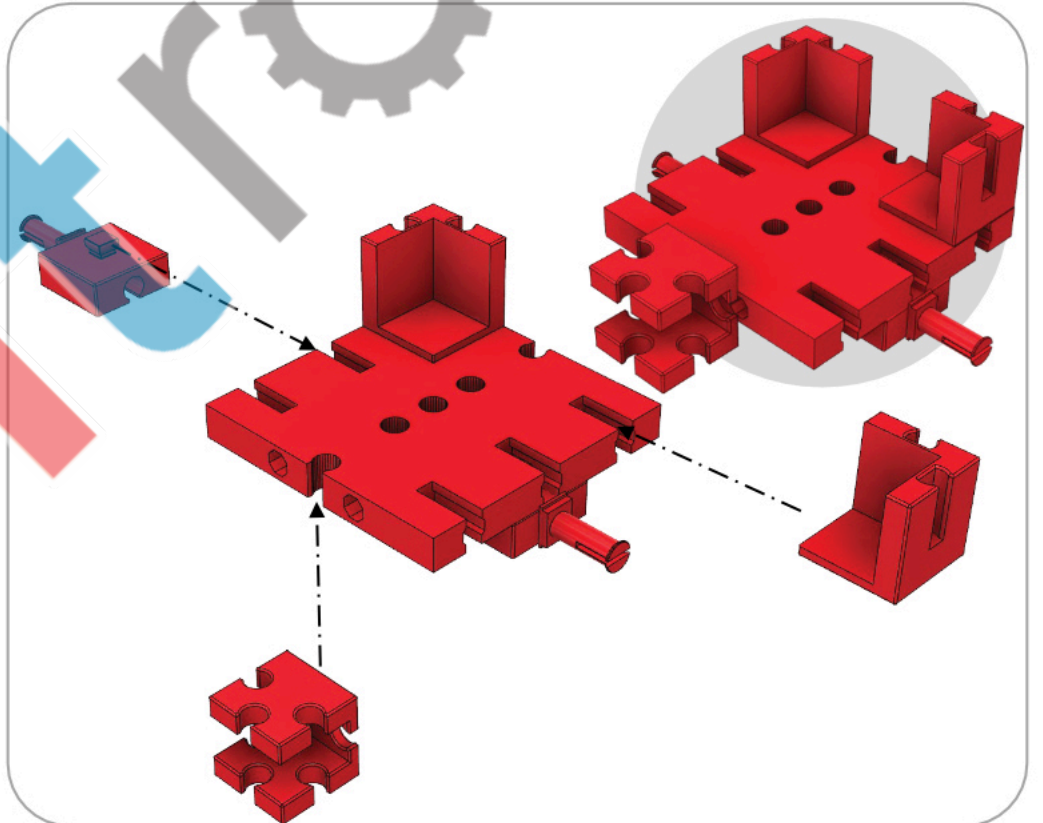

5

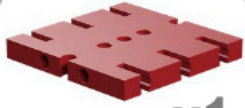

x1



x1



x2



x1

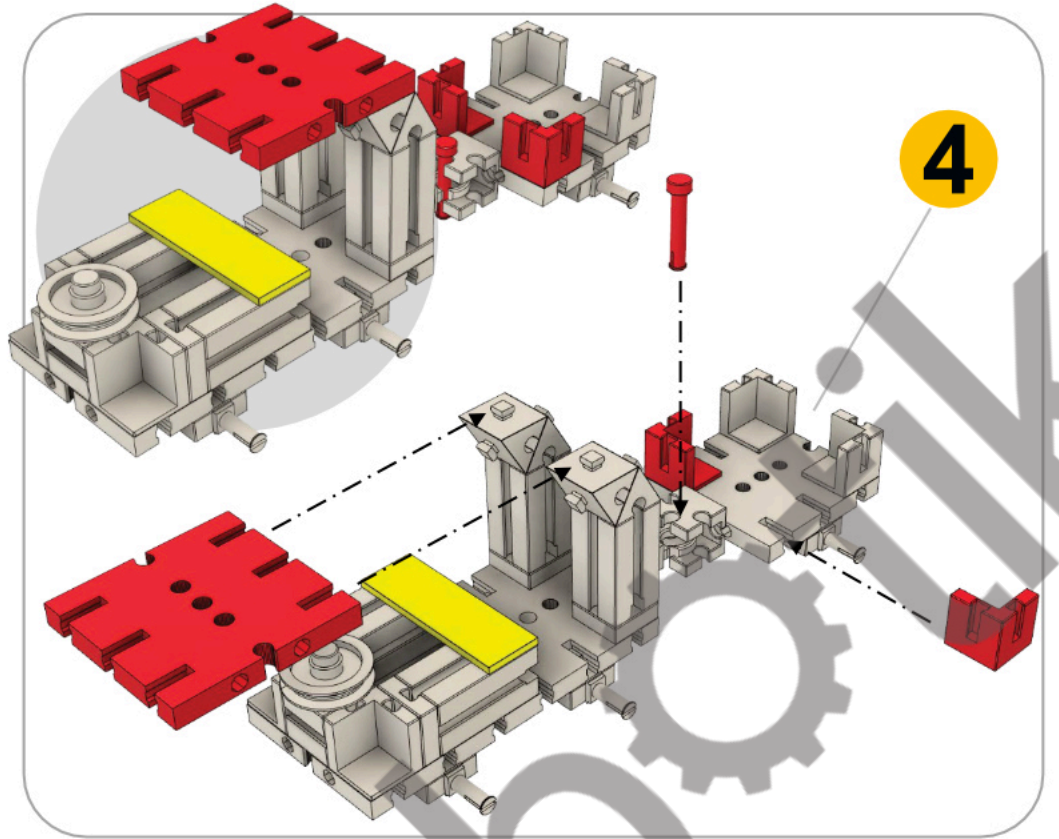

6



x6



x2



x4

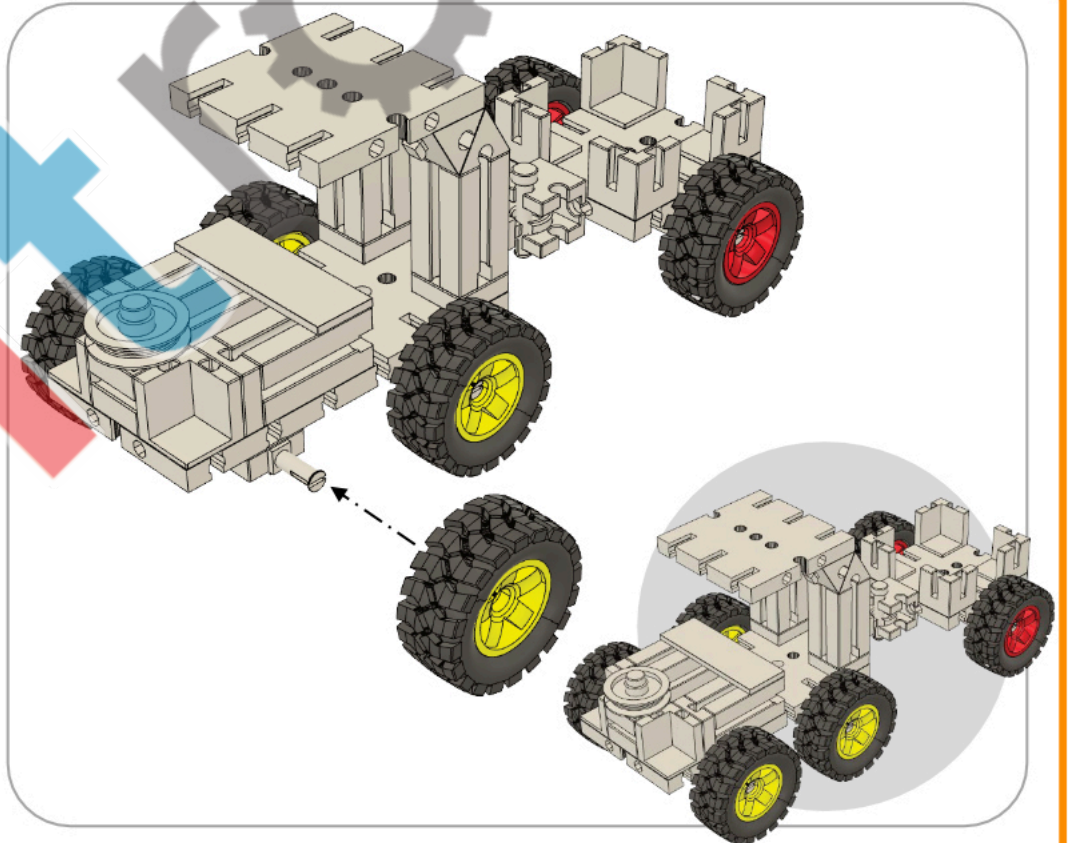

7



x2

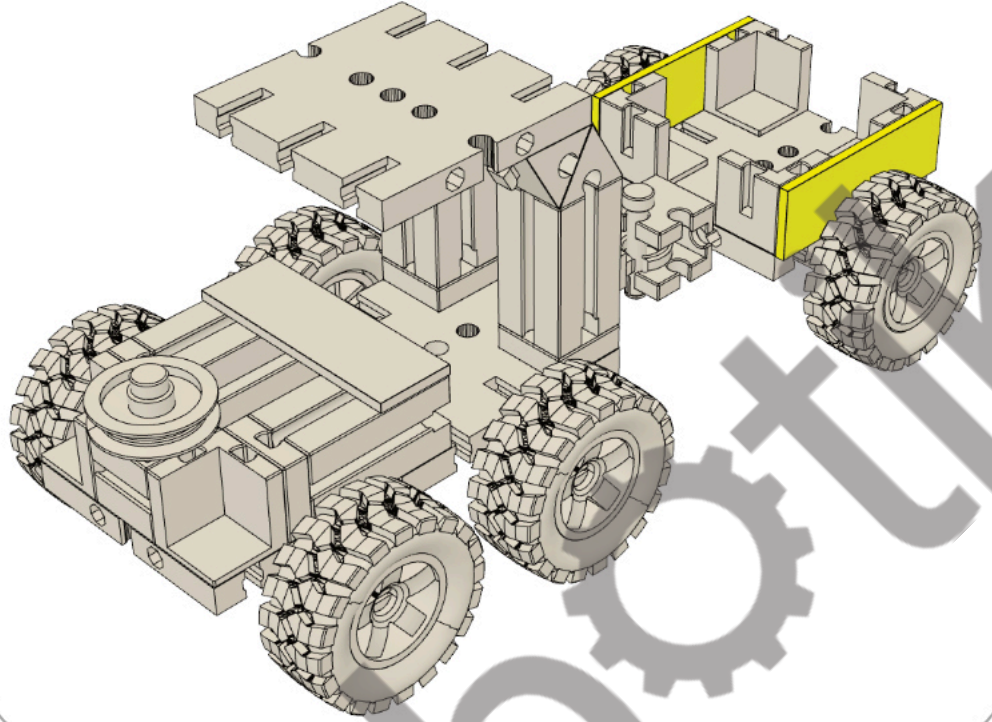

TRAKTÖR

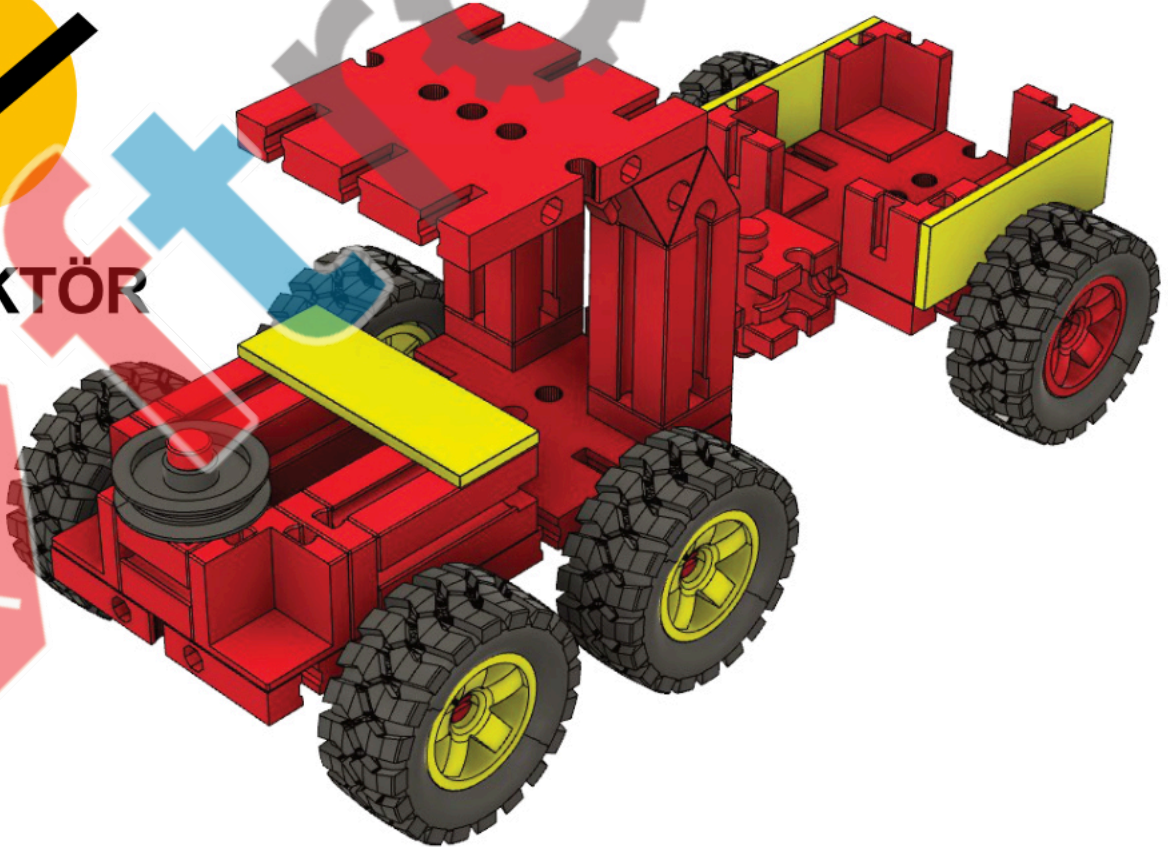

Etkinlik 8.3.1 Traktör

 **Görev:** Grup arkadaşlarınız ile traktörlerin günlük hayatta ne işimize yaradığını tartışınız. Düşüncelerinizi aşağıdaki boşluğa not ediniz.

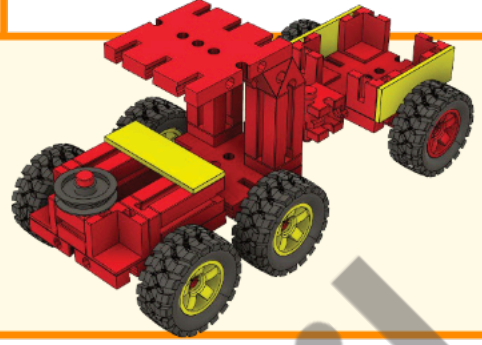

Çalışma Sayfası

Etkinlik 8.3.2 Traktörlerin özellikleri

 **Görev:** Traktörleri diğer araçlardan ayıran en belirgin özellikler sizce nelerdir? Düşündüğünüz özellikleri maddeler halinde aşağıdaki tabloya yazınız.

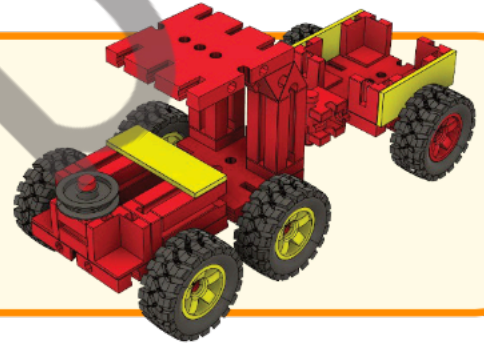

Çalışma Sayfası

Traktörlerin özellikleri

1	
2	
3	
4	
5	
6	
7	
8	

Etkinlik 8.3.3

Traktörler neden yavaş?

 **Görev:** Sizce traktörler neden diğer araçlara göre daha yavaş hareket ederler? Düşüncelerinizi aşağıdaki boşluğa yazınız.

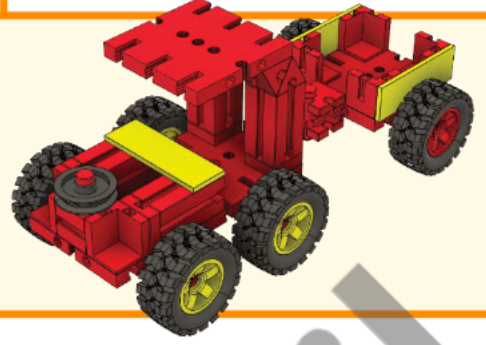

Çalışma Sayfası

8.4

TASARIMLAR

Tasarım 8.4.1

Benim sevimli traktörüm

 **Görev:** Kutularınızdaki parçaları kullanarak mevcut traktörünüzden farklı bir traktör tasarlayınız ve aşağıdaki boş alana bu traktörünüzün farklılıklarını yazınız ve tasarımını, çizimini yapınız.

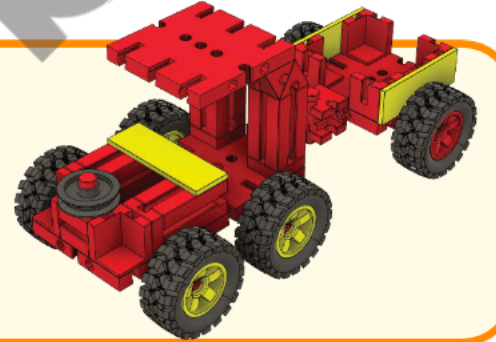

Çalışma Sayfası